

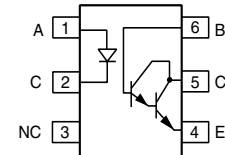

Optocoupler, Photodarlington Output, High Gain, With Base Connection

Features

- Isolation test voltage, 5300 V_{RMS}
- Coupling capacitance, 0.5 pF
- Lead-free component
- Component in accordance to RoHS 2002/95/EC and WEEE 2002/96/EC

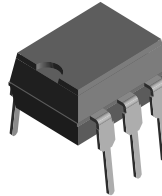

Agency Approvals

- UL1577, File No. E52744 System Code J



1179005

- DIN EN 60747-5-2 (VDE0884)
DIN EN 60747-5-5 pending
Available with Option 1

Order Information

Part	Remarks
H11B1	CTR > 500 %, DIP-6
H11B2	CTR > 200 %, DIP-6
H11B3	CTR > 100 %, DIP-6
H11B1-X007	CTR > 500 %, SMD-6 (option 7)
H11B1-X009	CTR > 500 %, SMD-6 (option 9)
H11B2-X009	CTR > 200 %, SMD-6 (option 9)

For additional information on the available options refer to Option Information.

Description

The H11B1/ H11B2/ H11B3 are industry standard optocouplers, consisting of a gallium arsenide infrared LED and a silicon photodarlington.

Absolute Maximum Ratings

T_{amb} = 25 °C, unless otherwise specified

Stresses in excess of the absolute Maximum Ratings can cause permanent damage to the device. Functional operation of the device is not implied at these or any other conditions in excess of those given in the operational sections of this document. Exposure to absolute Maximum Rating for extended periods of the time can adversely affect reliability.

Input

Parameter	Test condition	Symbol	Value	Unit
Reverse voltage		V _R	3.0	V
Forward continuous current		I _F	60	mA
Power dissipation		P _{diss}	100	mW
Derate linearly from 25 °C			1.33	mW/°C

Output

Parameter	Test condition	Symbol	Value	Unit
Collector-emitter breakdown voltage		BV _{CEO}	25	V
Emitter-collector breakdown voltage		BV _{ECO}	7.0	V
Collector-base breakdown voltage		BV _{CBO}	30	V

Parameter	Test condition	Symbol	Value	Unit
Collector current (continuous)		I_C	100	mA
Power dissipation		P_{diss}	150	mW
Derate linearly from 25 °C			2.0	mW/°C

Coupler

Parameter	Test condition	Symbol	Value	Unit
Isolation test voltage	between emitter and detector, refer to standard climate 23 °C/50 %RH, DIN 50014	V_{ISO}	5300	V_{RMS}
Creepage			≥ 7.0	mm
Clearance			≥ 7.0	mm
Comparative tracking index per DIN IEC 112/VDE 0303, part 1			175	
Isolation resistance	$V_{IO} = 500 \text{ V}, T_{amb} = 25 \text{ °C}$	R_{IO}	$\geq 10^{12}$	Ω
	$V_{IO} = 500 \text{ V}, T_{amb} = 100 \text{ °C}$	R_{IO}	$\geq 10^{11}$	Ω
Total package dissipation (LED plus detector)		P_{tot}	260	mW
Derate linearly from 25 °C			3.5	mW/°C
Storage temperature		T_{stg}	- 55 to + 150	°C
Operating temperature		T_{amb}	- 55 to + 100	°C
Lead soldering time at 260 °C			10	sec.

Electrical Characteristics

$T_{amb} = 25 \text{ °C}$, unless otherwise specified

Minimum and maximum values are testing requirements. Typical values are characteristics of the device and are the result of engineering evaluation. Typical values are for information only and are not part of the testing requirements.

Input

Parameter	Test condition	Part	Symbol	Min	Typ.	Max	Unit
Forward voltage	$I_F = 50 \text{ mA}$	H11B1	V_F		1.1	1.5	V
		H11B2	V_F		1.1	1.5	V
	$I_F = 10 \text{ mA}$	H11B3	V_F		1.1	1.5	V
Reverse current	$V_R = 3.0 \text{ V}$		I_R			10	μA
Junction capacitance	$V_F = 0 \text{ V}, f = 1.0 \text{ MHz}$		C_j		50		pF

Output

Parameter	Test condition	Symbol	Min	Typ.	Max	Unit
Collector-emitter breakdown voltage	$I_C = 1.0 \text{ mA}, I_F = 0 \text{ mA}$	BV_{CEO}	30			V
Emitter-collector breakdown voltage	$I_E = 100 \text{ }\mu\text{A}, I_F = 0 \text{ mA}$	BV_{ECO}	7.0			V
Collector-base breakdown voltage	$I_C = 100 \text{ }\mu\text{A}, I_F = 0 \text{ mA}$	BV_{CBO}	30			V
Collector-emitter leakage current	$V_{CE} = 10 \text{ V}, I_F = 0 \text{ mA}$	I_{CEO}			100	nA

Coupler

Parameter	Test condition	Symbol	Min	Typ.	Max	Unit
Saturation voltage collector-emitter	$I_C = 1.0 \text{ mA}$, $I_C = 1.0 \text{ mA}$	V_{CEsat}			1.0	V
Capacitance (input-output)		C_{IO}		0.5		pF

Current Transfer Ratio

Parameter	Test condition	Part	Symbol	Min	Typ.	Max	Unit
DC Current Transfer Ratio	$V_{CE} = 5.0 \text{ V}$, $I_F = 1.0 \text{ mA}$	H11B1	CTR_{DC}	500			%
		H11B2	CTR_{DC}	200			%
		H11B3	CTR_{DC}	100			%

Switching Characteristics

Parameter	Test condition	Symbol	Min	Typ.	Max	Unit
Switching times	$I_F = 5.0 \text{ mA}$, $V_{CE} = 10 \text{ V}$, $R_L = 100 \Omega$	t_{on}		5.0		μs
		t_{off}		30		μs

Typical Characteristics ($T_{amb} = 25^\circ\text{C}$ unless otherwise specified)

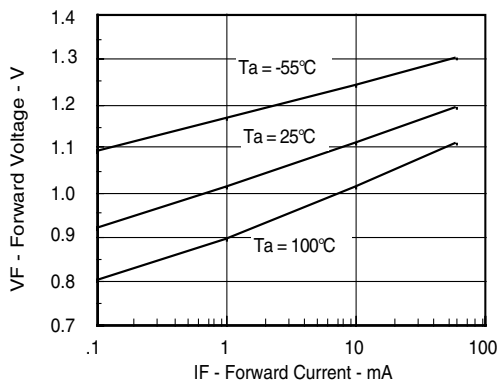

ih11b1_01

Figure 1. Forward Voltage vs. Forward Current

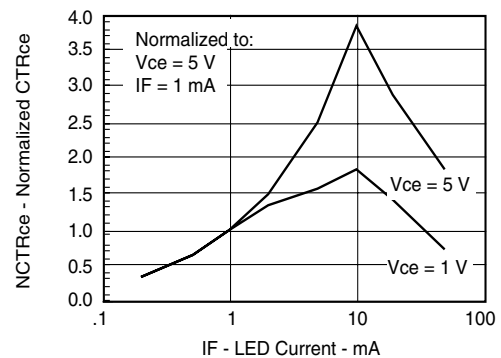

ih11b1_02

Figure 2. Normalized Non-Saturated and Saturated CTR_{CE} vs. LED Current

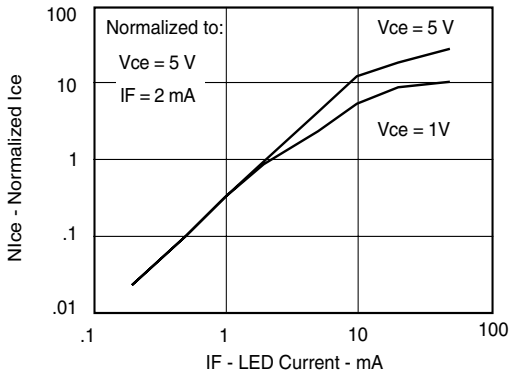

ih11b1_03

Figure 3. Normalized Non-Saturated and Saturated I_{CE} vs. LED Current

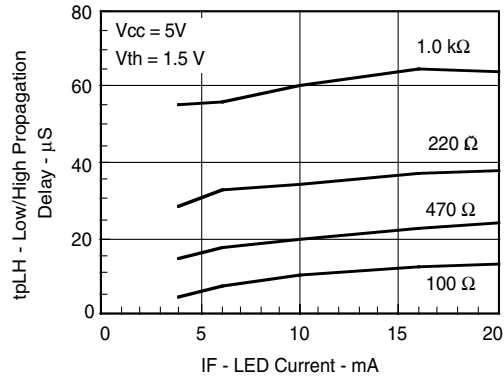

ih11b1_06

Figure 6. Low to High Propagation Delay vs. Collector Load Resistance and LED Current

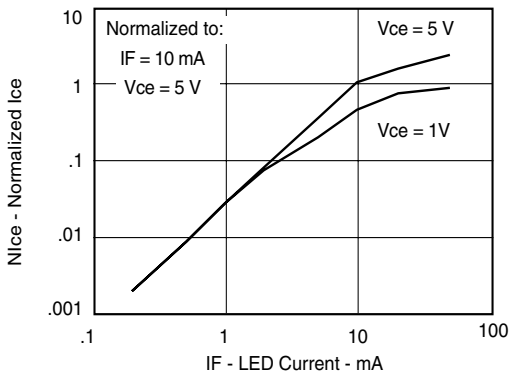

ih11b1_04

Figure 4. Normalized Non-Saturated and Saturated Collector-Emitter Current vs. LED Current

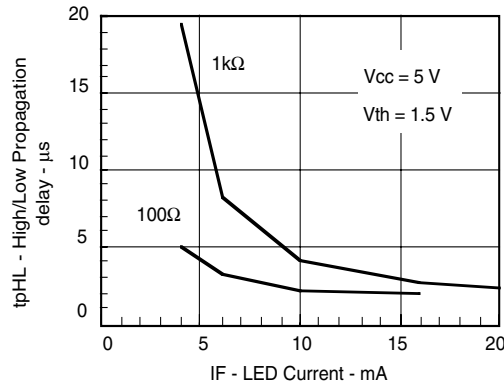

ih11b1_07

Figure 7. High to low Propagation Delay vs. Collector Load Resistance and LED Current

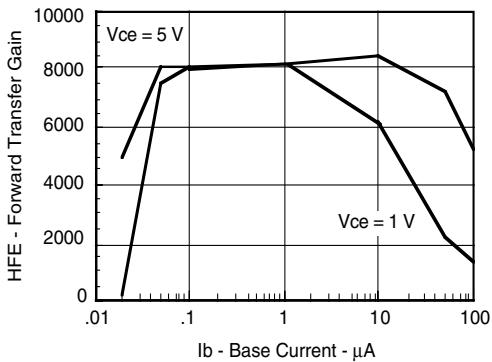

ih11b1_05

Figure 5. Non-Saturated and Saturated HFE vs. Base Current

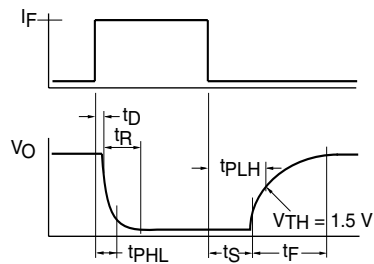

ih11b1_08

Figure 8. Switching Waveform

Figure 9. Switching Schematic

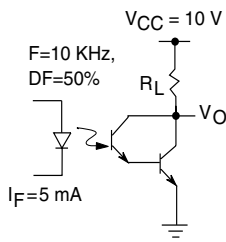

ih11b1_09

Package Dimensions in Inches (mm)

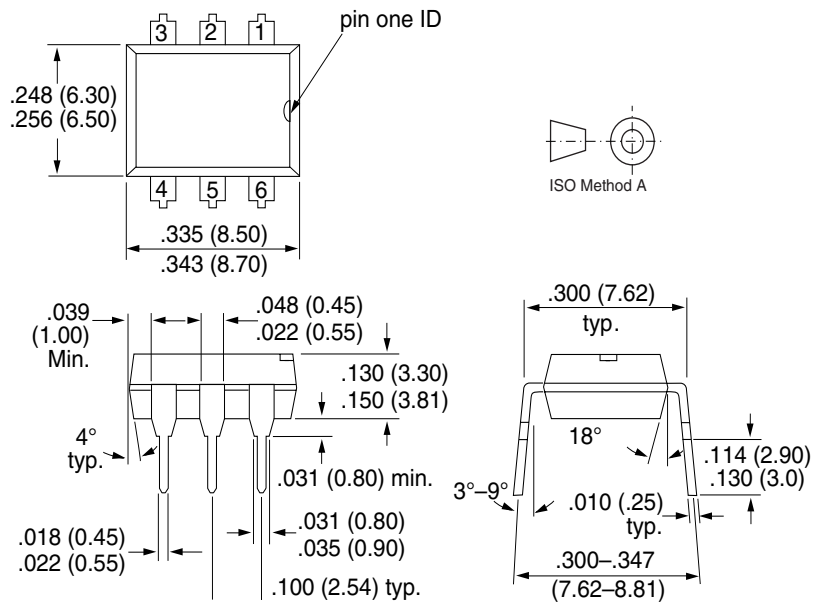

ii78004

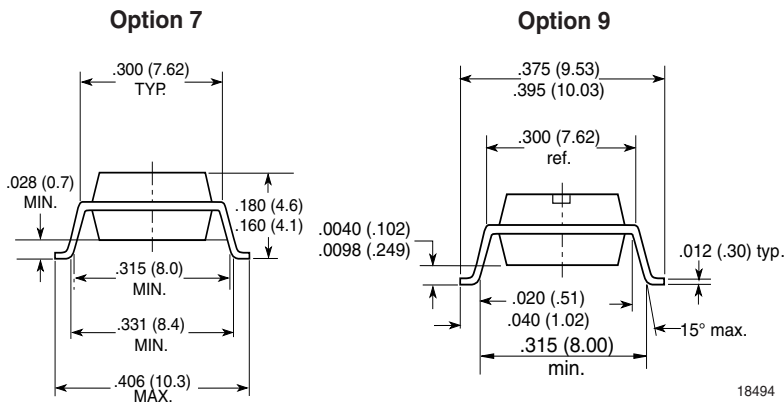



Ozone Depleting Substances Policy Statement

It is the policy of Vishay Semiconductor GmbH to

1. Meet all present and future national and international statutory requirements.
2. Regularly and continuously improve the performance of our products, processes, distribution and operating systems with respect to their impact on the health and safety of our employees and the public, as well as their impact on the environment.

It is particular concern to control or eliminate releases of those substances into the atmosphere which are known as ozone depleting substances (ODSs).

The Montreal Protocol (1987) and its London Amendments (1990) intend to severely restrict the use of ODSs and forbid their use within the next ten years. Various national and international initiatives are pressing for an earlier ban on these substances.

Vishay Semiconductor GmbH has been able to use its policy of continuous improvements to eliminate the use of ODSs listed in the following documents.

1. Annex A, B and list of transitional substances of the Montreal Protocol and the London Amendments respectively
2. Class I and II ozone depleting substances in the Clean Air Act Amendments of 1990 by the Environmental Protection Agency (EPA) in the USA
3. Council Decision 88/540/EEC and 91/690/EEC Annex A, B and C (transitional substances) respectively.

Vishay Semiconductor GmbH can certify that our semiconductors are not manufactured with ozone depleting substances and do not contain such substances.

We reserve the right to make changes to improve technical design and may do so without further notice.

Parameters can vary in different applications. All operating parameters must be validated for each customer application by the customer. Should the buyer use Vishay Semiconductors products for any unintended or unauthorized application, the buyer shall indemnify Vishay Semiconductors against all claims, costs, damages, and expenses, arising out of, directly or indirectly, any claim of personal damage, injury or death associated with such unintended or unauthorized use.

Vishay Semiconductor GmbH, P.O.B. 3535, D-74025 Heilbronn, Germany
Telephone: 49 (0)7131 67 2831, Fax number: 49 (0)7131 67 2423